

REV.	DESCRIPTION	DATE
A	New Drawing	2022/12/29

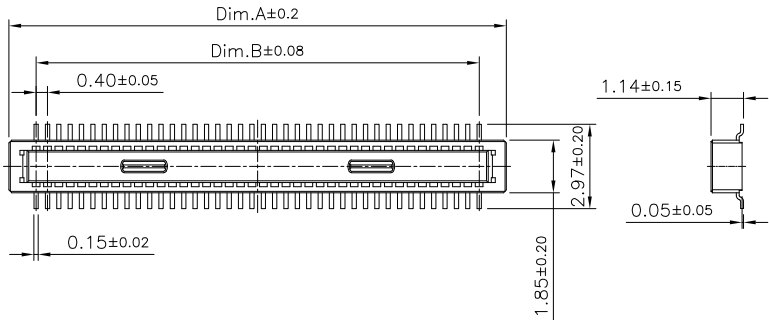

Mating with:  
"BABG-XXXG1145BOLI-C"

Specifications:  
 Current Rating: 0.3A AC,DC  
 Voltage Rating: 30V AC,DC  
 Contact Resistance: 90m ohm.Max  
 Insulation Resistance: 50M ohm.Min  
 Withstanding Voltage: 100V AC/Minute  
 Operating Temperature Range: -35°C~+85°C

Material:  
 Insulator: LCP(UL94V-0)  
 Insulator Color: Black  
 Contact: Phosphor bronze  
 Plated: Gold

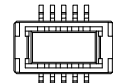
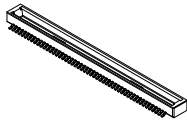
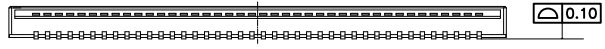

For 10 · 16P

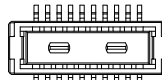

For 20~60P

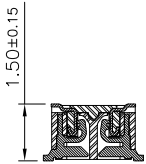

Matting drawing

Dimension Information:

Pin.No	Dim.A	Dim.B
10	3.52	1.60
16	4.72	2.80
20	5.52	3.60
30	7.52	5.60
40	9.52	7.60
50	11.52	9.60
60	13.52	11.60

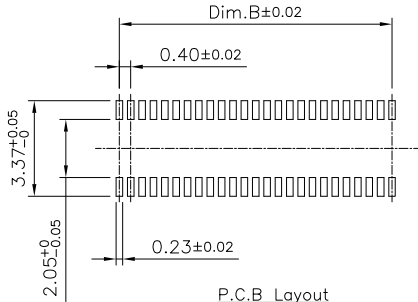

P.C.B Layout

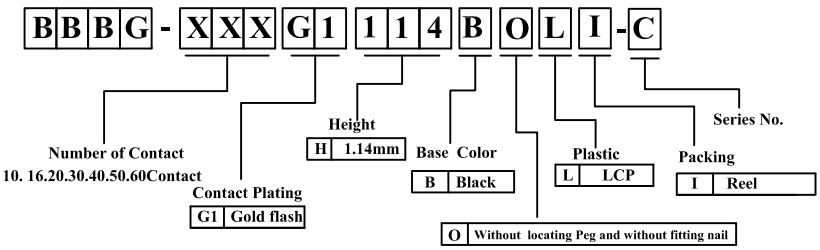

RoHS compliant

竣豪電子股份有限公司  
**Superior Tech Co., Ltd.**

General Tolerance		TITLE	PH 0.4mm Male BTB	
X. ± 0.5		DRAWN	DATE	DWG. NO.
.X ± 0.3		Tom	12-29-22'	T230
.XX ± 0.2		CHECK	DATE	PART NO.
.XXX ± 0.1		APPROVED	DATE	BBBG-XXXG1114BOLI-C
角度	± 5°			CUSTOMER NO.

REV.	UNIT	SCALE	
A	mm	1:1	