

REV.	DESCRIPTION	DATE
A	New Drawing	2022/06/22

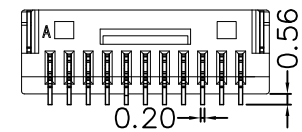

NOTE:  
 Current rating:1A AC,DC  
 Voltage rating:50V AC,DC  
 Temperature range:-25℃~+85℃  
 Insulation resistance:100MΩ/Min  
 Withstanding voltage:500V AC/minute  
 Contact resistance:30mΩ/Max

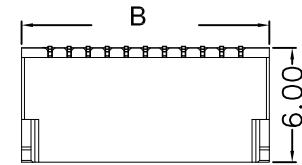
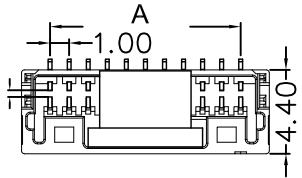
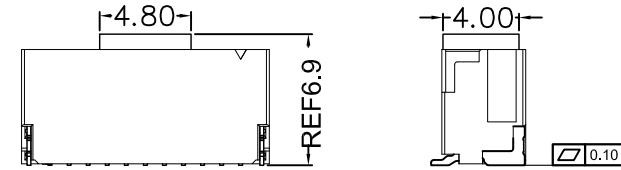
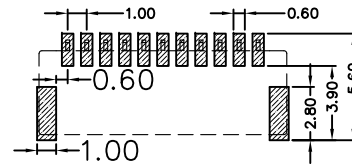

Recommended P.C.B Layout  
 General Tolerance±0.05

TABLE:

PIN NO.	Dimension mm		Q'ty/BAG
	A	B	
2	2.00	5.00	1000PCS
3	2.00	5.00	1000PCS
4	3.00	6.00	1000PCS
5	4.00	7.00	1000PCS
6	5.00	8.00	1000PCS
7	6.00	9.00	1000PCS
8	7.00	10.00	1000PCS
9	8.00	11.00	1000PCS
10	9.00	12.00	1000PCS
11	10.00	13.00	1000PCS
12	11.00	14.00	1000PCS
13	12.00	15.00	1000PCS
14	13.00	16.00	1000PCS
15	14.00	17.00	1000PCS

Wafer:WRAB-SSXXXT2ONLE-C25-A  
 Wafer:WRAB-HSXXXT2ONLI-C25-A  
 Housing:WRAB-H100XXXNAA-C25-A  
 Terminal:CU-PXX-C25-A

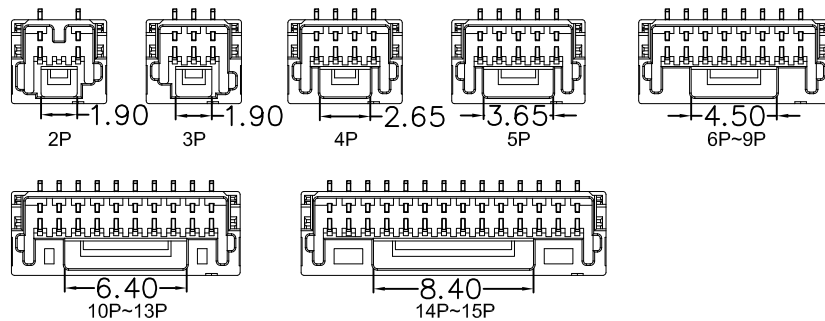

WRAB-SSXXXT2ONLE-C25-A

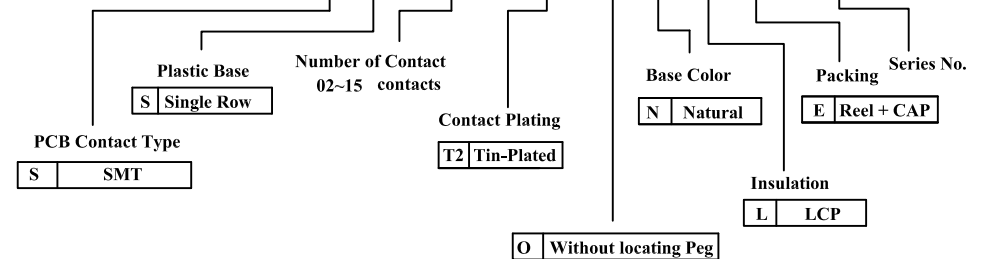

RoHS compliant

竣豪電子股份有限公司  
**Superior Tech Co., Ltd.**

General Tolerance		TITLE		WAFER PH1.0 立式SMT H6.0	
X. ± 0.5		DRAWN		DATE	
.X ± 0.3		Jacky		06-22-22'	
.XX ± 0.2		CHECK		DATE	
.XXX ± 0.1		Tom		06-22-22'	
角度 ± 5°		APPROVED		DATE	
		Tom		06-22-22'	
				NO. D080	
				PART NO. WRAB-SSXXXT2ONLE-C25-A	
				CUSTOMER NO.	

REV.	UNIT	SCALE	
A	mm	1:1	