

REV.	DESCRIPTION	DATE
A	New Drawing	2022/01/17

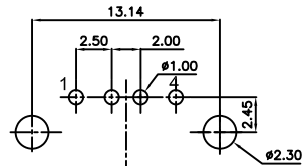

RECOMMENDED PCB LAYOUT
TOP VIEW
TOLERANCE:±0.05mm
PCB THICKNESS:1.60±0.05mm

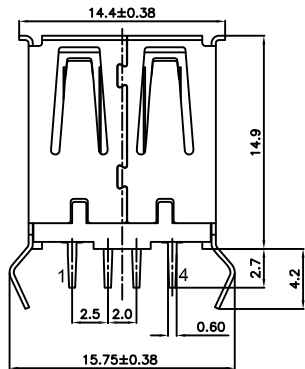
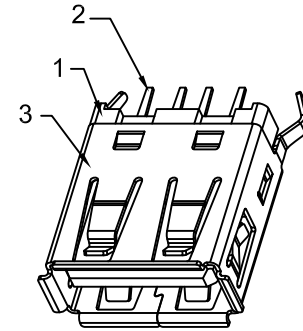
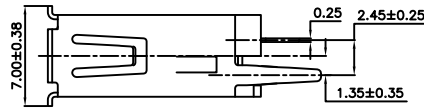
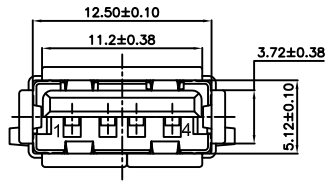
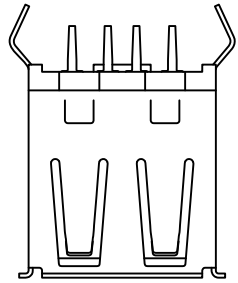
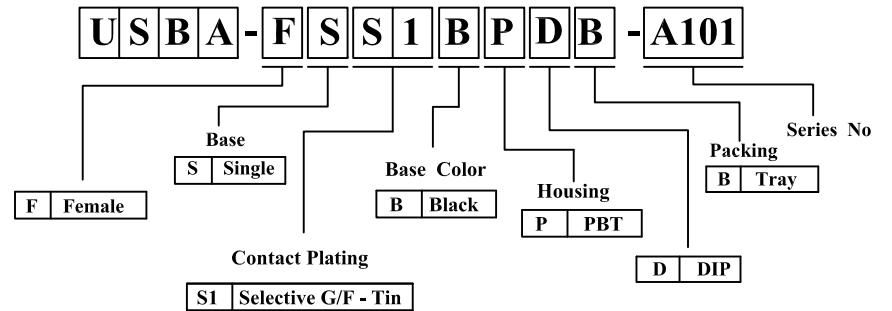

No	Name	Material	Finish
1	Housing	Thermoplastic	
2	Terminal	Copper Alloy	Gold - Tin Plated
3	Shell	Alloy	Ni Plated

RoHS compliant

竣豪電子股份有限公司
Superior Tech Co., Ltd.

General Tolerance		TITLE	USB A TYPE Female ,DIP PBT料	
X. ± 0.5		DRAWN	DATE	NO.
.X ± 0.3		Jacky	01-17-22'	T007
.XX ± 0.2		CHECK	DATE	PART NO.
.XXX ± 0.1		Tom	01-17-22'	USBA-FSS1BPDB-A101
角度	± 5°	APPROVED	DATE	CUSTOMER NO.
		Tom	01-17-22'	

REV.	UNIT	SCALE
A	mm	1:1

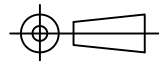

(Q2-R03-01A) ST-R05-07