

REV.	DESCRIPTION	DATE
A	New Drawing	2022/06/16

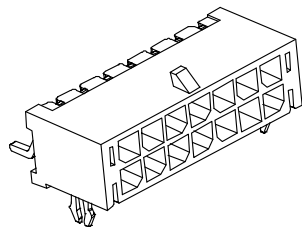

Specifications:
 Current Rating: 5.0A AC,DC
 Voltage Rating: 250V AC,DC
 Contact Resistance: 10m ohm.Max
 Insulation Resistance: 1000M ohm.Min
 Withstanding Voltage: 1500V AC/Minute
 Operating Temperature Range: -25°C ~ +105°C

Material:
 Insulator: LCP(UL94V-0)
 Insulator Color: Black
 Contact: Copper Alloy
 Plated: Tin Plated

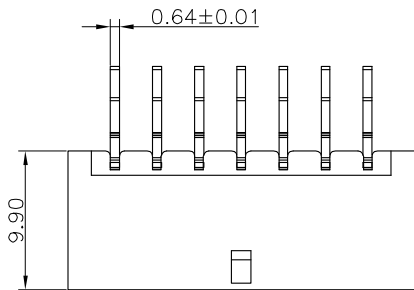
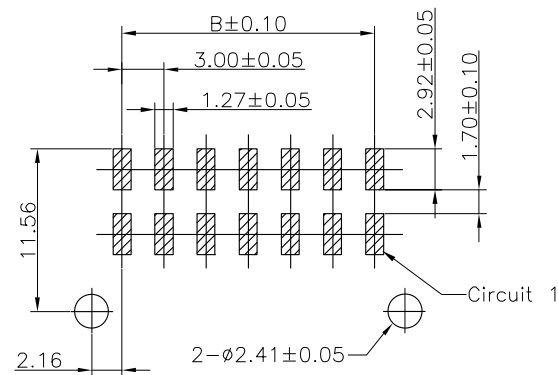
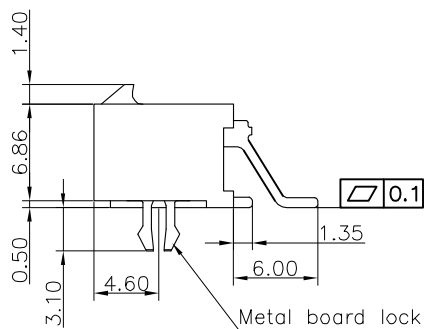
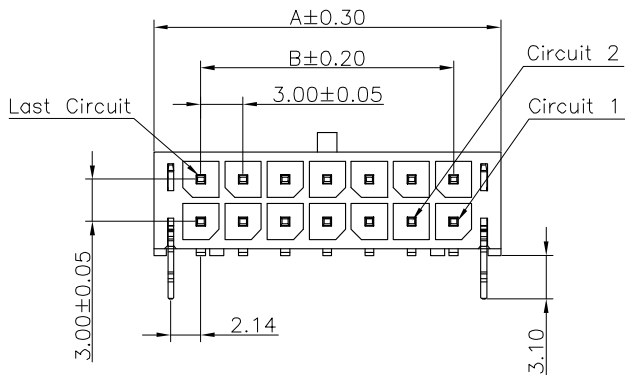

P.C.B LAYOUT

Circuits	Dimension		Circuits	Dimension	
	A	B		A	B
2	6.7	—	14	24.7	18.0
4	9.7	3.0	16	27.7	21.0
6	12.7	6.0	18	30.7	24.0
8	15.7	9.0	20	33.7	27.0
10	18.7	12.0	22	36.7	30.0
12	21.7	15.0	24	39.7	33.0

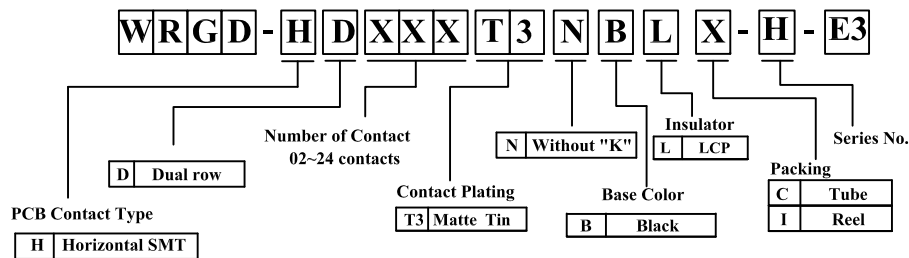

RoHS compliant

竣豪電子股份有限公司
Superior Tech Co., Ltd.

General Tolerance		TITLE	Micro FIT PH3.0 90° SMT 帶魚叉柱	
X. ± 0.5		DRAWN	Jacky	DATE 06-16-22'
.X ± 0.3				NO. T230
.XX ± 0.2		CHECK	Tom	DATE 06-16-22'
.XXX ± 0.1				PART NO. WRGD-HDXXXT3NBLX-H-E3
REV. A	UNIT mm	SCALE 1:1	APPROVED Tom	DATE 06-16-22'
			CUSTOMER NO.	

REV.	DESCRIPTION	DATE
A	New Drawing	2022/06/16

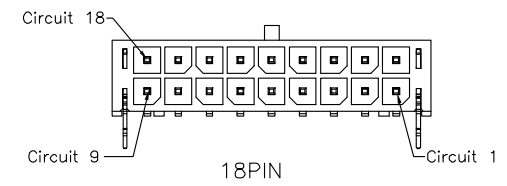
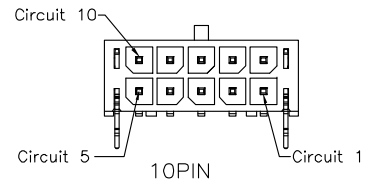
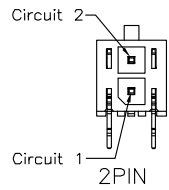
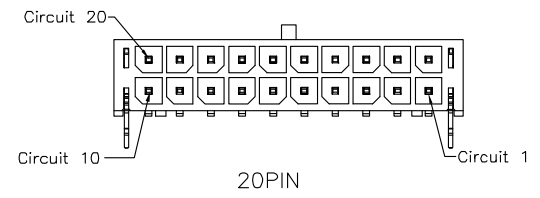
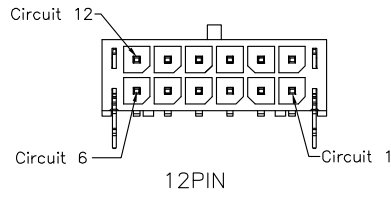
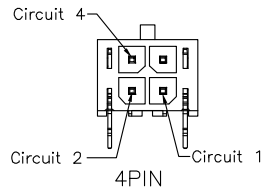
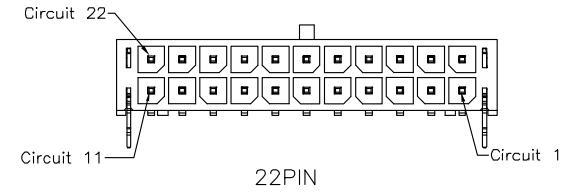
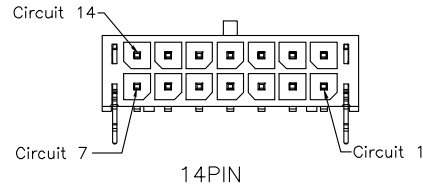
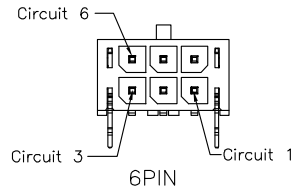
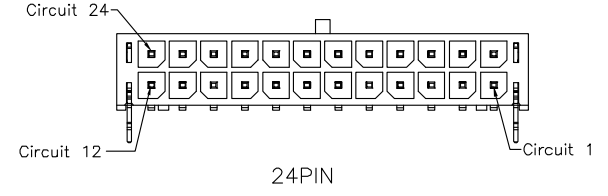
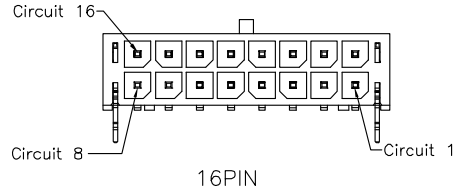
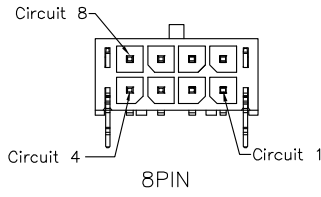

2~24P Protection Key Drawing(Ref.)

RoHS compliant

竣豪電子股份有限公司
Superior Tech Co., Ltd.

General Tolerance		TITLE	WRGD-HDXXXT3NBLX-H-E3 PIN位圖	
X. ± 0.5		DRAWN Jacky	DATE	NO.
.X ± 0.3			06-16-22'	T230
.XX ± 0.2		CHECK Tom	DATE	PART NO.
.XXX ± 0.1			06-16-22'	WRGD-HDXXXT3NBLX-H-E3
角度 ± 5°		APPROVED Tom	DATE	CUSTOMER NO.
			06-16-22'	

REV. A	UNIT mm	SCALE 1:1	
------------------	-------------------	---------------------	--

REV.	DESCRIPTION	DATE
A	New Drawing	2022/06/16

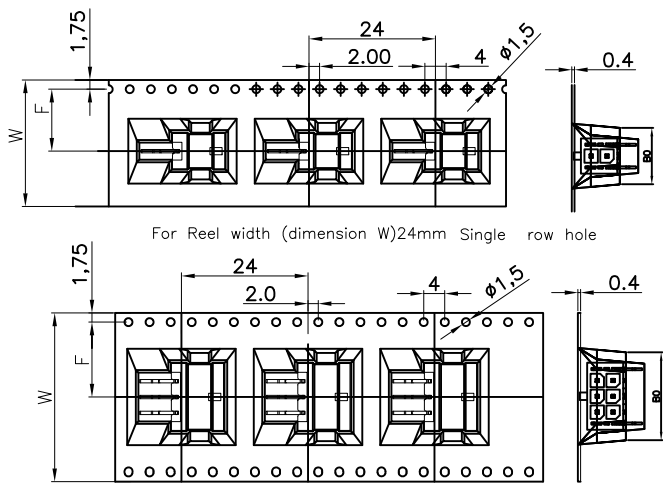
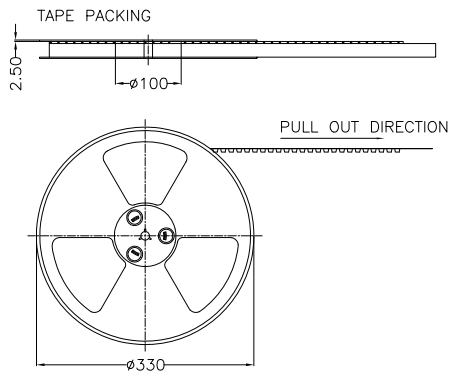

Pin.	W	F	Pcs/R	R/Cartron	Pcs/Cartron
2	24	11.5	200	9	1800
4	24	11.5	200	9	1800
6	32	14.2	200	7	1400
8	44	20.2	200	5	1000
10	44	20.2	200	5	1000
12	44	20.2	200	5	1000
14	44	20.2	200	5	1000
16	56	26.2	200	4	800
18	56	26.2	200	4	800
20	56	26.2	200	4	800
22	56	26.2	200	4	800
24	56	26.2	200	4	800

For Reel width (dimension W)24mm Single row hole

- Note:
- All dimensions meet EIA-481-3 requirements.
 - Material : BK Conductive Polystyrene Alloy
100% recyclable.
 - Thickness : 0.40±0.05mm
 - Component load per 13" reel :200 pcs.
 - Carton Size:350*350*296(mm)

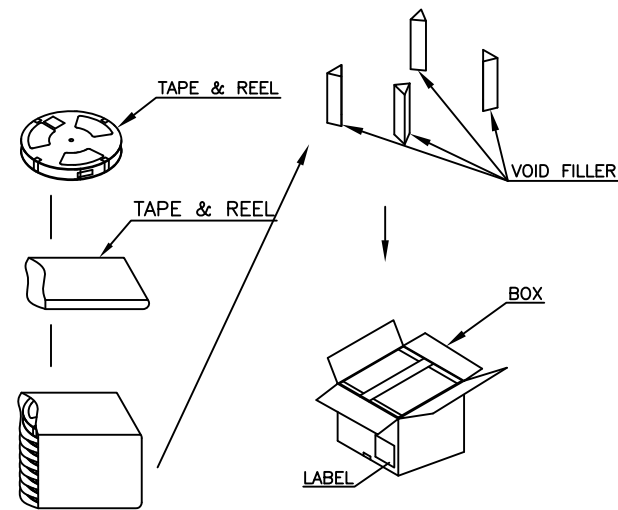

RoHS compliant

竣豪電子股份有限公司
Superior Tech Co., Ltd.

General Tolerance		TITLE	WRGD-HDXXXT3NBLX-H-E3 包裝圖	
X. ± 0.5		DRAWN Jacky	DATE	NO.
.X ± 0.3			06-16-22'	T230
.XX ± 0.2		CHECK Tom	DATE	PART NO.
.XXX ± 0.1			06-16-22'	WRGD-HDXXXT3NBLX-H-E3
REV.	UNIT	SCALE	APPROVED	DATE
A	mm	1:1	Tom	06-16-22'
			CUSTOMER NO.	

