

REV.	DESCRIPTION	DATE
A	New Drawing	2023/04/07

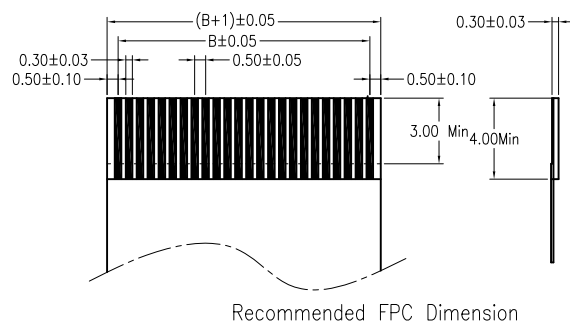
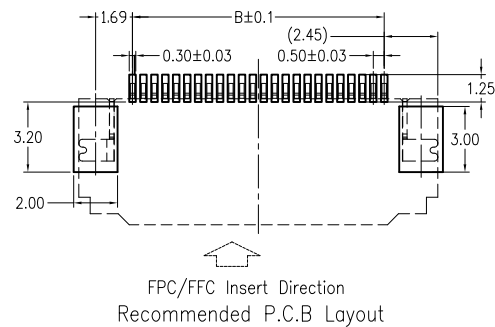
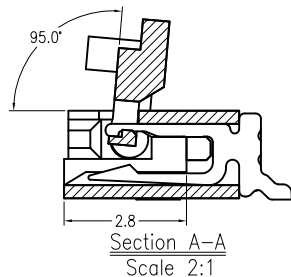
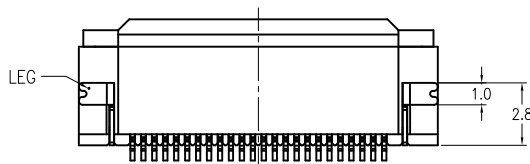
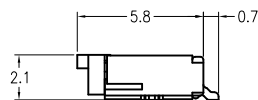
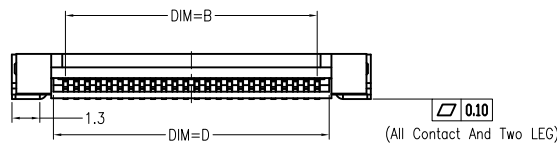
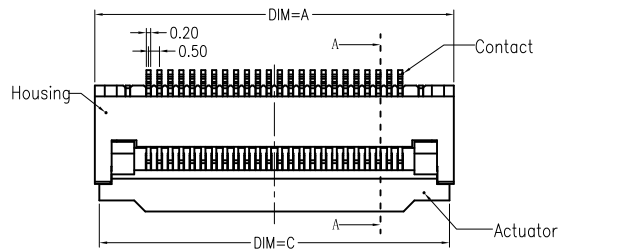

Note:

1. Material
 - 1.1: Housing: LCP UL94-V0 Color:Black.
 - 1.2: Actuator: LCP UL94-V0 Color:Black.
 - 1.3: Contact: Phosphor Bronze.
 - 1.4: LEG: Brass.
2. Plating
 - 2.1: Contact: Matte Tin Or Gold Plating Nickel
 - 2.2: LEG: Matte Tin Plating Over Nickel.
3. Rating:
 - 3.1: Operating Voltage: 50V AC/DC.
 - 3.2: Current Rating: 0.4A AC/DC.
 - 3.3: Operating Temperature: -25°C~+85°C.

Position	4 ~ 69 Contact
Dimension	
A	(No. of Position*0.5)+4.40
B	(No. of Position*0.5)-0.50
C	(No. of Position*0.5)+4.00
D	(No. of Position*0.5)+0.50

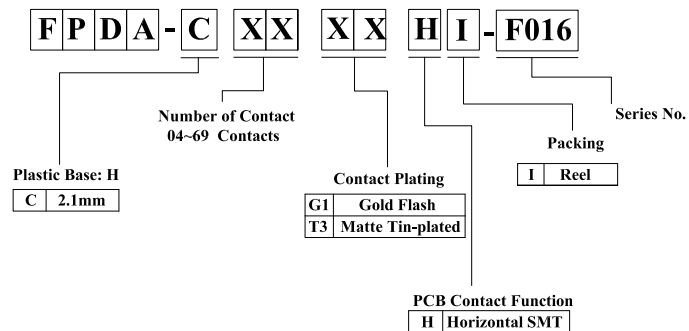

竣豪電子股份有限公司
Superior Tech Co., Ltd.

REV.	A	UNIT	mm	SCALE	1:1		General Tolerance	TITLE	FPC PH0.5 90° SMT,掀蓋下接式,LCP料				
							X. ± 0.5	DRAWN	Jacky	DATE	04-07-23'	NO.	D081
							.X ± 0.3	CHECK	Tom	DATE	04-07-23'	PART NO.	FPDA-CXXXXHI-F016
							.XX ± 0.2	APPROVED	Tom	DATE	04-07-23'	CUSTOMER NO.	
							.XXX ± 0.1	角度	± 5°				

(Q2-R03-01A) ST-R05-07